

Operating Instructions

MC Type (Dual Moving Coil) Stereo Cartridge

AT-F7 MC

AT-F3/III MC

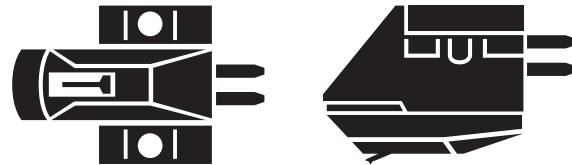

Features

● AT-F7

Based on the AT-F3/III with a nude elliptical stylus (0.2 × 0.7 mil) and an aluminum pipe cantilever, the AT-F7 uses φ 0.07 mm stainless suspension wire, which serves an important role as a fulcrum point for audio signal transfer. This stainless wire is used for higher-quality MC-type cartridges. This stabilizes the fulcrum position and enables auditory lateralization to provide excellent expression of the high-frequency range. This model, with its high-quality sound comparable to the more expensive model, provides outstanding value for performance, which pleases those who appreciate the sound quality of analog records.

● AT-F3/III

The AT-F3/III is equipped with an elliptical stylus (curvature radius: 0.2 × 0.7 mil). This stylus tip is mounted on an aluminum pipe cantilever in order to achieve lighter weight. This is the model with high-quality performance: an example of the culmination of Audio-Technica's specialized technical expertise in engineering MC cartridges with features such as the vertical stabilizer mechanism.

AT-F7

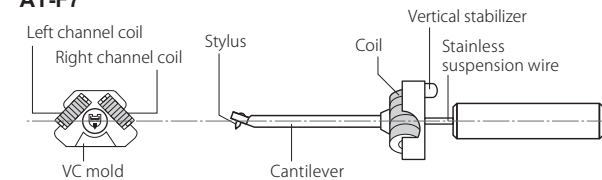

AT-F3/III

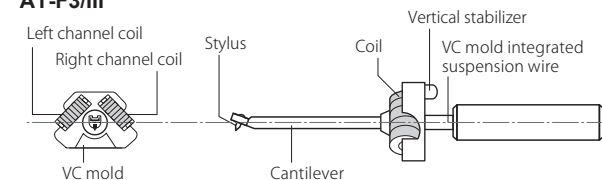

● Neodymium magnet for dramatically increased magnetic energy

The neodymium magnet provides maximum energy (BHmax of 50[kJ/m³]), while the pure iron yoke provides excellent properties. Together, they further boost the magnetic field concentrated in the coil gap area.

● PCOCC used for coils and terminal pins

PCOCC does not give rise to crystalline resistance in the transmission direction, enabling audiophiles to enjoy pure transmissions.

PCOCC

PCOCC = Pure Copper by Ohno Continuous Casting process
(Mono-crystalline high-purity oxygen-free copper)



Caution

This stereo cartridge was designed with painstaking attention given to safety, but trouble may occur if it is used incorrectly. Heed the following precautions to prevent accidents from occurring.

- Keep the cartridge out of the reach of small children.
Failure to heed this precaution may result in accidents or malfunctioning.
- Keep the plastic bag provided with the cartridge out of the reach of small children and away from flames.
Failure to heed this precaution may result in accidents or a fire.
- Do not put this cartridge in a location where it will be exposed to direct sunlight, near heating appliances or in places with a high temperature and high humidity or with high concentrations of dust.
Failure to heed this precaution may result in malfunctioning or trouble.
- Do not touch the cartridge's cantilever fulcrum.
Failure to heed this precaution may result in malfunctioning.
- Do not attempt to disassemble or remodel the cartridge.
Failure to heed this precaution may result in malfunctioning.
- Do not subject the cartridge to strong impact.
Failure to heed this precaution may result in malfunctioning.

● Dual moving coil with high separation and wide response

Our unique moving coil type cartridge has a basic structure where one cylindrical coil is used for the left channel and another is used for the right channel. This structure by which power is generated independently for the left and right channels physically provides outstanding separation characteristics. The leakage of signals from one channel into the other exerts a decisive influence on the stereo expanse as well as on the sound quality. This is because this leakage is tantamount to creating irregular cross modulation. The reason why the dual moving coil system delivers such a clear and finely delineated sound quality is no doubt due to the system's naturally excellent separation. The AT-F7 and AT-F3/III adopt a reverse V-shaped formation for the two left and right coils to reduce the vibration mass as seen from the stylus tip.

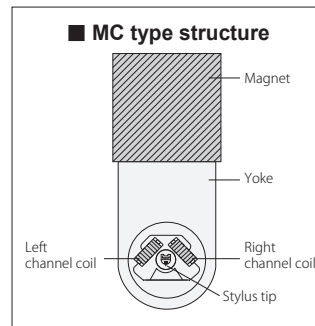

● High-rigidity VC mold combined with potassium titanate minimize unnecessary vibration (AT-F7 only)

The VC structure that holds the coils in place is made of a hard resin, which is combined with potassium titanate for increased strength and rigidity. The result is less weight and an unprecedented reduction of unnecessary vibration.

● Durable construction dedicated to achieving increased rigidity

Using a precision-crafted sturdy aluminum alloy as the base, the body's structure is made of hard resin which minimizes parasitic resonance. This achieves greater rigidity and improves signal-to-noise ratio.

Operation

* The stylus section is extremely fragile. Exercise sufficient care in handling it.

(1) Mount the cartridge onto the headshell.

Loosely secure the screws to ensure that the cantilever fulcrum will not be damaged.

(2) While noting the polarities of the output terminals, insert the lead wire tips.

The figure below shows the layout of the headshell lead wires of a universal tonearm. Connect the lead wires with the same color to the output terminals of the cartridge. If the lead wire tips are loose, pinch them a little, and then insert. Under no circumstances must any heat such as that accompanying soldering operations be applied to the output terminals. The PCOCC wires* provided are the best match for the lead wires.
*Only the AT-F7 is equipped with PCOCC wires.

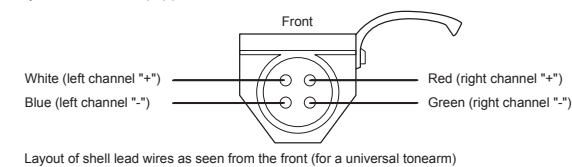

Layout of shell lead wires as seen from the front (for a universal tonearm)

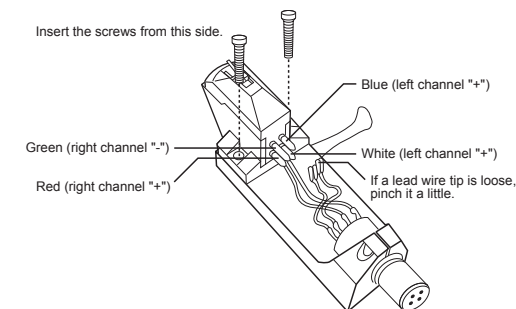

(3) Decide on the exact position where the cartridge is to be mounted. (Overhang adjustment)

Adjust the overhang by following the instructions in the record player's manual. If the procedure is not clear, adjust the stylus tip position to the cartridge which originally came attached to the record player. (See figure below.) The sound quality will suffer if the difference is great, so the overhang should be adjusted ideally to within +/-1 mm of that of the original cartridge.

*After completing the adjustment, tighten up the screws evenly at the left and right.

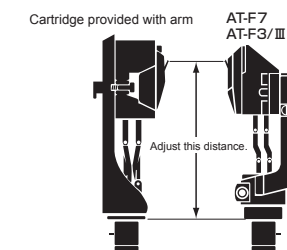

(4) Adjust the tracking force. The standard level is 2.0 g.

The appropriate tracking force of this cartridge is in the range of 1.8 to 2.2 g (standard level: 2.0 g). Normally, it is set to 2.0 g. Depending on the air temperature, condition of the records to be played or other operating conditions (such as heavy vibration), adjust the tracking force, but ensure that it is adjusted to the level within the applicable range.

(5) When it is possible to adjust the arm height:

Adjust the height so that the bottom of the headshell and the surface of the records are made parallel as seen from the side. If the arm is not positioned at the right height, the cartridge body may touch the records and/or the sound quality may suffer.

(6) A transformer, head amplifier or discrete phono equalizer is required to make the connection with the amplifier.

If the amplifier comes with a PHONO input (MC position) setting, it can be used as is. However, to make the most of the cartridge's sound quality, use of a step-up transformer (purchased separately), head amplifier or phono equalizer (purchased separately) is recommended. For details on the connections, consult the operating instructions of the component used.

(7) Keep the stylus tip clean at all times.

Use the brush provided to remove the dirt and dust on the stylus tip. A stylus cleaner (purchased separately) is recommended to remove stubborn dirt.

Clean the stylus tip by moving the brush from the base toward the stylus tip. When the cartridge has been removed from the arm, do not forget to attach the protector, and store the cartridge away from the amplifier and other heat sources.

How to clean the stylus tip

Be absolutely sure to move the brush in the direction in which the record rotates.



(8) When the stylus is to be replaced, replace the entire cartridge.

Take the used cartridge to your dealer. This cartridge, or any other model which is desired among the lineup of MC cartridges sold by Audio-Technica, is available at the stylus replacement price. Once the production of this cartridge has ended, one of the MC cartridges still being marketed will be available at the stylus replacement price. Please make a note of this.

Specifications

Type	: Moving coil (MC)
Frequency response	: 15 to 50,000 Hz
Output voltage	: 0.35 mV (1 kHz, 5cm/sec.)
Channel separation	: 27 dB (1 kHz)
Channel balance	: 1.5 dB (1 kHz)
Tracking force	: 1.8 to 2.2 g (standard: 2.0 g)
Coil impedance	: 12 Ω (1 kHz)
DC resistance	: 12 Ω
Recommended load impedance	: Min. 100Ω (when head amplifier is connected)
Coil inductance	: 25 μH (1 kHz)
Static compliance	: 35 × 10 ⁻⁶ cm/dyne
Dynamic compliance	: 9 × 10 ⁻⁶ cm/dyne (100 Hz)
Stylus	: Nude elliptical stylus 0.2 × 1.7 mil
Suspension wires	: Stainless (AT-F7), integrated with resin (AT-F3/III)
Vertical tracking angle	: 23 degrees
Dimensions	: 17.3 (H) × 16.8 (W) × 25.4 (L) mm
Weight	: 5.0 g

● Accessories: screwdriver (× 1), washers (× 2), protector (× 1), cartridge mounting screws 5 mm (× 2), 9 mm (× 2), nuts (× 2), brush (× 1), set of PCOCC lead wires (× 1)
(The brush and lead wires are equipped only with AT-F7.)

(Specifications are subject to change without notice due to improvements.)

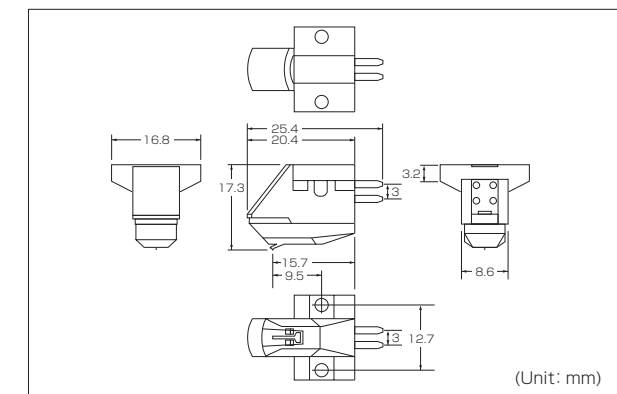

(Unit: mm)